

INSTRUCTION MANUAL

Multi Tool

TM3000C

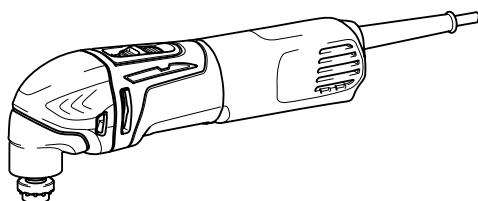

012849

 DOUBLE INSULATION

IMPORTANT: Read Before Using.

ENGLISH (Original instructions)

SPECIFICATIONS

Model		TM3000C
Oscillation per minute		6,000 - 20,000 (min ⁻¹)
Oscillation angle, left/right		1.6° (3.2° total)
Overall length		275 mm
Net weight	without dust extraction attachment	1.4 kg
	with dust extraction attachment	1.5 kg
Safety class		II/III

- Due to our continuing program of research and development, the specifications herein are subject to change without notice.
- Specifications may differ from country to country.
- Weight according to EPTA-Procedure 01/2003

END202-6

Symbols

The following show the symbols used for the equipment. Be sure that you understand their meaning before use.



- Read instruction manual.



- DOUBLE INSULATION



- Wear safety glasses.



- Only for EU countries

Do not dispose of electric equipment together with household waste material! In observance of European Directive 2002/96/EC on waste electric and electronic equipment and its implementation in accordance with national law, electric equipment that have reached the end of their life must be collected separately and returned to an environmentally compatible recycling facility.

ENE080-1

Intended use

The tool is intended for sawing and cutting wood, plastic, gypsum, non-ferrous metals, and fastening elements (e. g. unhardened nails and staples). It is also intended for working soft wall tiles, as well as dry sanding and scraping of small surfaces. It is especially for working close to edge and flush cutting.

ENG905-1

Noise

The typical A-weighted noise level determined according to EN60745:

Work mode: Sanding

Sound pressure level (L_{pA}) : 74 dB (A)

Uncertainty (K) : 3 dB (A)

The noise level under working may exceed 80 dB (A).

Work mode: Cutting with plunge cut saw blade

Sound pressure level (L_{pA}) : 78 dB (A)

Uncertainty (K) : 3 dB (A)

The noise level under working may exceed 80 dB (A).

Work mode: Cutting with segmental saw blade

Sound pressure level (L_{pA}) : 76 dB (A)

Uncertainty (K) : 3 dB (A)

The noise level under working may exceed 80 dB (A).

Work mode: Scraping

Sound pressure level (L_{pA}) : 77 dB (A)

Uncertainty (K) : 3 dB (A)

The noise level under working may exceed 80 dB (A).

Wear ear protection

ENG900-1

Vibration

The vibration total value (tri-axial vector sum) determined according to EN60745:

Work mode: Sanding

Vibration emission (a_h) : 2.5 m/s² or less

Uncertainty (K) : 1.5 m/s²

Work mode: Cutting with plunge cut saw blade

Vibration emission (a_h) : 6.5 m/s²

Uncertainty (K) : 1.5 m/s²

Work mode: Cutting with segmental saw blade

Vibration emission (a_h) : 3.0 m/s²

Uncertainty (K) : 1.5 m/s²

Work mode: Scraping

Vibration emission (a_h) : 5.5 m/s²

Uncertainty (K) : 1.5 m/s²

- The declared vibration emission value has been measured in accordance with the standard test method and may be used for comparing one tool with another.
- The declared vibration emission value may also be used in a preliminary assessment of exposure.

⚠ WARNING:

- The vibration emission during actual use of the power tool can differ from the declared emission value depending on the ways in which the tool is used.
- Be sure to identify safety measures to protect the operator that are based on an estimation of exposure in the actual conditions of use (taking account of all parts of the operating cycle such as the times when the tool is switched off and when it is running idle in addition to the trigger time).

ENH101-17

For European countries only

EC Declaration of Conformity

Makita declares that the following Machine(s):

Designation of Machine:

Multi Tool

Model No./ Type: TM3000C

Conforms to the following European Directives:

2006/42/EC

They are manufactured in accordance with the following standard or standardized documents:

EN60745

The technical file in accordance with 2006/42/EC is available from:

Makita, Jan-Baptist Vinkstraat 2, 3070, Belgium

31.12.2013



000331

Yasushi Fukaya
Director

Makita, Jan-Baptist Vinkstraat 2, 3070, Belgium

General Power Tool Safety Warnings

⚠ WARNING Read all safety warnings and all instructions. Failure to follow the warnings and instructions may result in electric shock, fire and/or serious injury.

Save all warnings and instructions for future reference.

The term "power tool" in the warnings refers to your mains-operated (corded) power tool or battery-operated (cordless) power tool.

Work area safety

1. **Keep work area clean and well lit.** Cluttered or dark areas invite accidents.
2. **Do not operate power tools in explosive atmospheres, such as in the presence of flammable liquids, gases or dust.** Power tools create sparks which may ignite the dust or fumes.
3. **Keep children and bystanders away while operating a power tool.** Distractions can cause you to lose control.

Electrical safety

4. **Power tool plugs must match the outlet. Never modify the plug in any way. Do not use any adapter plugs with earthed (grounded) power tools.** Unmodified plugs and matching outlets will reduce risk of electric shock.
5. **Avoid body contact with earthed or grounded surfaces such as pipes, radiators, ranges and refrigerators.** There is an increased risk of electric shock if your body is earthed or grounded.
6. **Do not expose power tools to rain or wet conditions.** Water entering a power tool will increase the risk of electric shock.
7. **Do not abuse the cord. Never use the cord for carrying, pulling or unplugging the power tool. Keep cord away from heat, oil, sharp edges or moving parts.** Damaged or entangled cords increase the risk of electric shock.
8. **When operating a power tool outdoors, use an extension cord suitable for outdoor use.** Use of a cord suitable for outdoor use reduces the risk of electric shock.
9. **If operating a power tool in a damp location is unavoidable, use a residual current device (RCD) protected supply.** Use of an RCD reduces the risk of electric shock.
10. **Use of power supply via a RCD with a rated residual current of 30mA or less is always recommended.**

Personal safety

11. **Stay alert, watch what you are doing and use common sense when operating a power tool. Do not use a power tool while you are tired or under the influence of drugs, alcohol or medication.** A moment of inattention while operating power tools may result in serious personal injury.
12. **Use personal protective equipment. Always wear eye protection.** Protective equipment such as dust mask, non-skid safety shoes, hard hat, or hearing protection used for appropriate conditions will reduce personal injuries.
13. **Prevent unintentional starting. Ensure the switch is in the off-position before connecting to power source and/or battery pack, picking up or carrying the tool.** Carrying power tools with your finger on the switch or energising power tools that have the switch on invites accidents.
14. **Remove any adjusting key or wrench before turning the power tool on.** A wrench or a key left attached to a rotating part of the power tool may result in personal injury.
15. **Do not overreach. Keep proper footing and balance at all times.** This enables better control of the power tool in unexpected situations.
16. **Dress properly. Do not wear loose clothing or jewellery. Keep your hair, clothing, and gloves away from moving parts.** Loose clothes, jewellery or long hair can be caught in moving parts.
17. **If devices are provided for the connection of dust extraction and collection facilities, ensure these are connected and properly used.** Use of dust collection can reduce dust-related hazards.

Power tool use and care

18. **Do not force the power tool. Use the correct power tool for your application.** The correct power tool will do the job better and safer at the rate for which it was designed.
19. **Do not use the power tool if the switch does not turn it on and off.** Any power tool that cannot be controlled with the switch is dangerous and must be repaired.
20. **Disconnect the plug from the power source and/or the battery pack from the power tool before making any adjustments, changing accessories, or storing power tools.** Such preventive safety measures reduce the risk of starting the power tool accidentally.
21. **Store idle power tools out of the reach of children and do not allow persons unfamiliar with the power tool or these instructions to operate the power tool.** Power tools are dangerous in the hands of untrained users.
22. **Maintain power tools. Check for misalignment or binding of moving parts, breakage of parts and any other condition that may affect the power tool's operation. If damaged, have the power tool repaired before use.** Many accidents are caused by poorly maintained power tools.
23. **Keep cutting tools sharp and clean.** Properly maintained cutting tools with sharp cutting edges are less likely to bind and are easier to control.
24. **Use the power tool, accessories and tool bits etc. in accordance with these instructions, taking into account the working conditions and the work to be performed.** Use of the power tool for operations different from those intended could result in a hazardous situation.

Service

25. **Have your power tool serviced by a qualified repair person using only identical replacement parts.** This will ensure that the safety of the power tool is maintained.
26. **Follow instruction for lubricating and changing accessories.**
27. **Keep handles dry, clean and free from oil and grease.**

GEB096-3

MULTI TOOL SAFETY WARNINGS

1. **This power tool is intended to function for sawing, cutting, grinding and sanding. Read all safety warnings, instructions, illustrations and specifications provided with this power tool.** Failure to follow all instructions listed below may result in electric shock, fire and/or serious injury.
2. **Hold power tool by insulated gripping surfaces, when performing an operation where the cutting accessory may contact hidden wiring or its own cord.** Cutting accessory contacting a "live" wire may make exposed metal parts of the power tool "live" and could give the operator an electric shock.
3. **Use clamps or another practical way to secure and support the workpiece to a stable platform.** Holding the work by hand or against your body leaves it unstable and may lead to loss of control.
4. **Position the cord clear of the spinning accessory.** If you lose control, the cord may be cut or snagged and your hand or arm may be pulled into the spinning accessory.
5. **Always use safety glasses or goggles.** Ordinary eye or sun glasses are NOT safety glasses.

6. **Avoid cutting nails. Inspect workpiece for any nails and remove them before operation.**
7. **Hold the tool firmly.**
8. **Make sure the application tool is not contacting the workpiece before the switch is turned on.**
9. **Keep hands away from moving parts.**
10. **Do not leave the tool running. Operate the tool only when hand-held.**
11. **Always switch off and wait for the blade to come to a complete stop before removing the blade from the workpiece.**
12. **Do not touch the application tool or the workpiece immediately after operation; they may be extremely hot and could burn your skin.**
13. **Do not operate the tool at no-load unnecessarily.**
14. **Always use the correct dust mask/respirator for the material and application you are working with.**
15. **Some material contains chemicals which may be toxic. Take caution to prevent dust inhalation and skin contact. Follow material supplier safety data.**
16. **This tool has not been waterproofed, so do not use water on the workpiece surface.**
17. **Ventilate your work area adequately when you perform sanding operations.**
18. **Use of this tool to sand some products, e.g. leaded paint surfaces, wood and metals could expose user and bystanders to dust containing hazardous substances. Use appropriate respiratory protection.**
19. **Be sure that there are no cracks or breakage on the pad before use. Cracks or breakage may cause a personal injury.**
20. **Do not use accessories which are not specifically designed and recommended by the tool manufacturer. Just because the accessory can be attached to your power tool, it does not assure safe operation.**
21. **Wear personal protective equipment. Depending on application, use face shield, safety goggles or safety glasses. As appropriate, wear hearing protectors, gloves and workshop apron capable of stopping small abrasive or workpiece fragments. The eye protection must be capable of stopping flying debris generated by various operations. The dust mask or respirator must be capable of filtering particles generated by your operation. Prolonged exposure to high intensity noise may cause hearing loss.**
22. **Keep bystanders a safe distance away from work area. Anyone entering the work area must wear personal protective equipment. Fragments of workpiece or of a broken accessory may fly away and cause injury beyond immediate area of operation.**
23. **Never lay the power tool down until the accessory has come to a complete stop. The spinning accessory may grab the surface and pull the power tool out of your control.**
24. **Do not run the power tool while carrying it at your side. Accidental contact with the accessory could snag your clothing, pulling the accessory into your body.**
25. **Do not operate the power tool near flammable materials. Sparks could ignite these materials.**
26. **Do not use accessories that require liquid coolants. Using water or other liquid coolants may result in electrocution or shock.**
27. **Always be sure that the tool is switched off and unplugged before carrying out any work on the tool.**
28. **If working place is extremely hot and humid, or badly polluted by conductive dust, use a short-circuit breaker (30 mA) to assure operator safety.**
29. **Always be sure you have a firm footing. Be sure no one is below when using the tool in high locations.**

SAVE THESE INSTRUCTIONS.

WARNING:

DO NOT let comfort or familiarity with product (gained from repeated use) replace strict adherence to safety rules for the subject product. **MISUSE** or failure to follow the safety rules stated in this instruction manual may cause serious personal injury.

FUNCTIONAL DESCRIPTION

⚠WARNING:

- Always be sure that the tool is switched off and unplugged before adjusting or checking function on the tool. Failure to switch off and unplug the tool may result in serious personal injury from accidental start-up.

Switch action

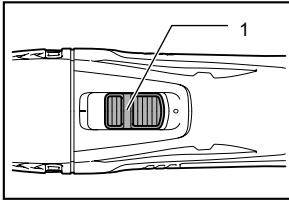

012768

1. Slide switch

⚠CAUTION:

- Before plugging in the tool, always check to see that the tool is switched off.

To start the tool, slide the slide switch toward the "I (ON)" position.

To stop the tool, slide the slide switch toward the "O (OFF)" position.

Adjusting the orbital stroke rate

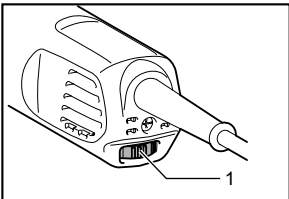

012852

1. Dial

The orbital stroke rate is adjustable. To change the orbital stroke rate, turn the dial between 1 and 5. The higher the number is, the higher the orbital stroke rate is. Preset the dial to the number suitable for your workpiece.

NOTE:

- The dial cannot be turned directly from 1 to 5 or from 5 to 1. Forcing the dial may damage the tool. When changing the dial direction, always turn the dial moving it through each intermediate number.

Constant speed control

Electronic speed control for obtaining constant speed. Possible to get fine finish, because the orbital stroke rate is kept constant even under load condition.

ASSEMBLY

⚠CAUTION:

- Always be sure that the tool is switched off and unplugged before carrying out any work on the tool.

Installing or removing application tool (optional accessory)

⚠WARNING:

- Do not install application tool upside down. Installing application tool upside down may damage the tool and cause serious personal injury.
- Install attachment tool in the correct direction according to your work. Application tool can be installed at an angle of every 30 degree.

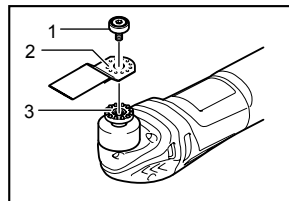

012888

1. Application tool installation bolt
2. Holes in the application tool
3. Protrusions of the tool flange

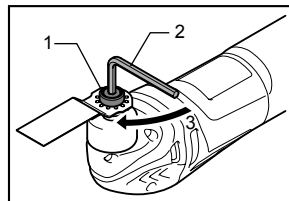

012851

1. Application tool installation bolt
2. Hex wrench
3. Tighten

Put an application tool (optional accessory) on the tool flange so that the protrusions of the tool flange fit in the holes in the application tool and secure the application tool by tightening the bolt firmly with the hex wrench.

When using sanding application tool, mount the application tool on the sanding pad so that it matches the sanding pad direction.

The sanding pad has a hook and loop type fitting system which allows easy and rapid fitting of a sanding paper.

As sanding papers have holes for dust extraction, mount a sanding paper so that the holes in a sanding paper match those in the sanding pad.

To remove a sanding paper, raise its end and peel it off. Loosen and remove the application tool installation bolt using a hex wrench and then take off the application tool.

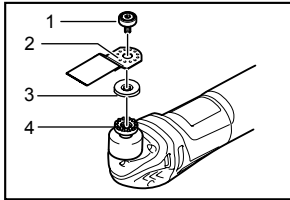

1. Application tool installation bolt
2. Holes in the application tool
3. Adapter
4. Protrusions of the tool flange

012850

When using application tools with a different type of installation section, use a correct adapter (optional accessory).

OPERATION

⚠WARNING:

- Before starting the tool and during operation, keep your hand and face away from the application tool.

⚠CAUTION:

- Do not apply excessive load to the tool which may cause a motor lock and stop the tool.

Cutting, sawing and scraping

⚠CAUTION:

- Do not move on the tool forcibly in the direction (eg. towards either side) of tool application with no cutting edge. It may damage the tool.

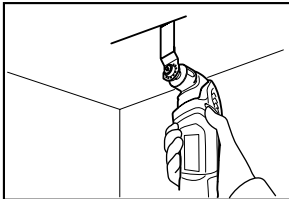

012889

Put the application tool on the workpiece. And then move the tool forward so that the application tool movement does not slow down.

NOTE:

- Forcing or excessive pressure on the tool may reduce efficiency.
- Before cutting operation, it is recommended to preset the orbital stroke rate 3 - 5.

Sanding

⚠CAUTION:

- Do not reuse a sanding paper used for sanding metal to sand wood.
- Do not use a worn sanding paper or sanding paper without grit.

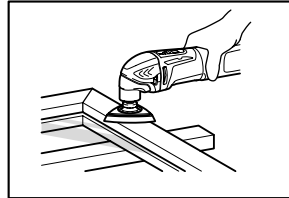

012853

Apply a sanding paper on the workpiece.

NOTE:

- Using a test material sample to try is recommendable to determine a correct orbital stroke rate suitable for your work.
- Use a sanding paper with the same grit until sanding the whole workpiece is completed. Replacing a sanding paper with different grit sanding paper may not get a fine finish.

Dust extraction attachment (optional accessory)

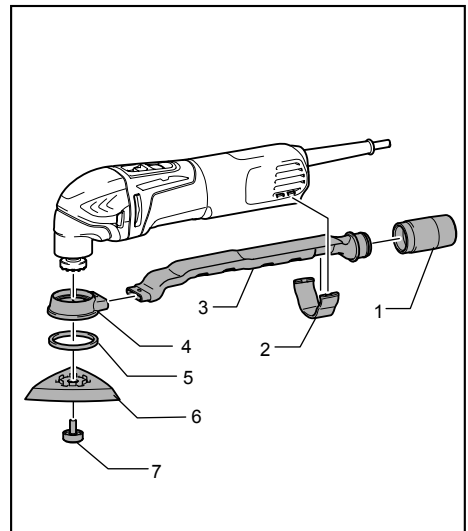

1. Joint
2. Nozzle band
3. Dust nozzle
4. Dust attachment
5. Felt ring
6. Pad
7. Application tool installation bolt

012854

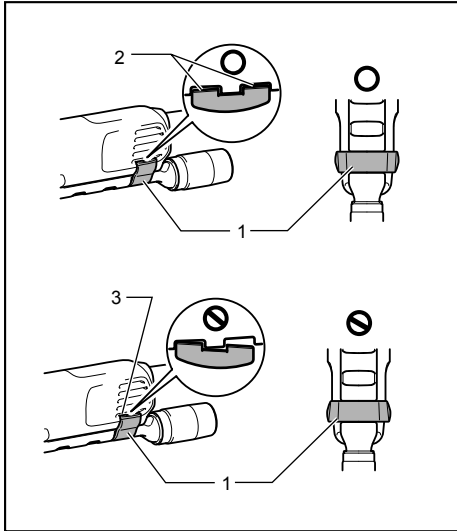

1. Nozzle band
2. Protrusions
3. Holes

013052

- Install joint, dust nozzle and dust attachment.
- Install the nozzle band on the tool so that its protrusions fit in the holes in the tool to secure it.
- Put the felt ring and the sanding pad on the dust attachment and then secure them with the application tool installation bolt.

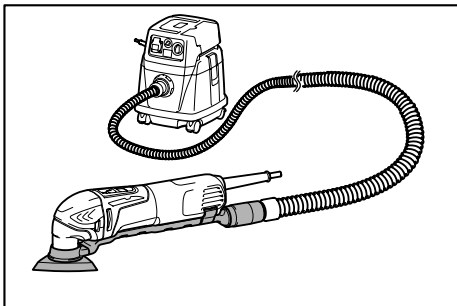

012855

When you wish to perform cleaner operation, connect a vacuum cleaner to your tool. Connect a hose of vacuum cleaner to the dust extraction attachment (optional accessory).

MAINTENANCE

⚠CAUTION:

- Always be sure that the tool is switched off and unplugged before attempting to perform inspection or maintenance.
- Never use gasoline, benzine, thinner, alcohol or the like. Discoloration, deformation or cracks may result.

To maintain product SAFETY and RELIABILITY, repairs, carbon brush inspection and replacement, any other maintenance or adjustment should be performed by Makita Authorized Service Centers, always using Makita replacement parts.

OPTIONAL ACCESSORIES

⚠CAUTION:

- These accessories or attachments are recommended for use with your Makita tool specified in this manual. The use of any other accessories or attachments might present a risk of injury to persons. Only use accessory or attachment for its stated purpose.

If you need any assistance for more details regarding these accessories, ask your local Makita Service Center.

- Segment saw blade
- Round saw blade
- Plunge cut saw blade
- Scraper (rigid)
- Scraper (flexible)
- Serrated seg blade
- General joint cutter
- HM remover
- HM seg saw blade
- HM sanding plate
- Diamond seg sawblade
- Sanding pad
- Adapter
- Abrasive paper delta (red / white / black)
- Fleece delta (medium / coarse / without grit)
- Polishing felt delta
- Hex wrench
- Dust extraction attachment

NOTE:

- Some items in the list may be included in the tool package as standard accessories. They may differ from country to country.

Makita Jan-Baptist Vinkstraat 2, 3070, Belgium
Makita Corporation Anjo, Aichi, Japan